

Each Norwell light fixture has a mounting bar or plate to secure it to the electrical junction box. No matter what type of mounting bar/plate your fixture uses, installation requires three basic steps.

1. Attach the mounting bar/plate to the electrical junction box.
2. Connect the electrical wires from the junction box to the electrical wires from the fixture. (Black to Black, White to White and Green to Ground).
3. Secure the fixture to the mounting bar/plate.

Norwell

Lighting

INSTRUCTIONS

4641

INSTALLATION OF FIXTURE

1. DETERMINE THE PREFERRED HANGING HEIGHT AND ADJUST THE REQUIRED RODS.
2. FEED THE WIRES THROUGH THE RODS AND CONNECT THEM TOGETHER.
3. SLIP CANOPY ASSEMBLY ALONG WIRE AND THREAD IT INTO THE TOP OF THE ROD ASSEMBLY.
4. ATTACH THE MOUNTING PLATE TO JUNCTION BOX WITH 2 JUNCTION BOX SCREWS.
5. CONNECT THE ELECTRICAL WIRES FROM YOUR JUNCTION BOX TO THE WIRES FROM THE CANOPY USING WIRE NUTS. (BLACK TO BLACK, WHITE TO WHITE, GREEN TO GROUND)
6. RAISE THE CANOPY OVER THE MOUNTING PLATE AND THEN SECURE IT WITH MOUNTING SCREWS.
7. INSTALL THE BULB (NOT INCLUDED) INTO THE SOCKET.
8. SLIP THE GLASS OVER THE SOCKET AND TO THE BRACKET AND LINE UP THE HOLES ON IT WITH THE HOLES ON THE BRACKET. SECURE IT WITH THE SCREW.

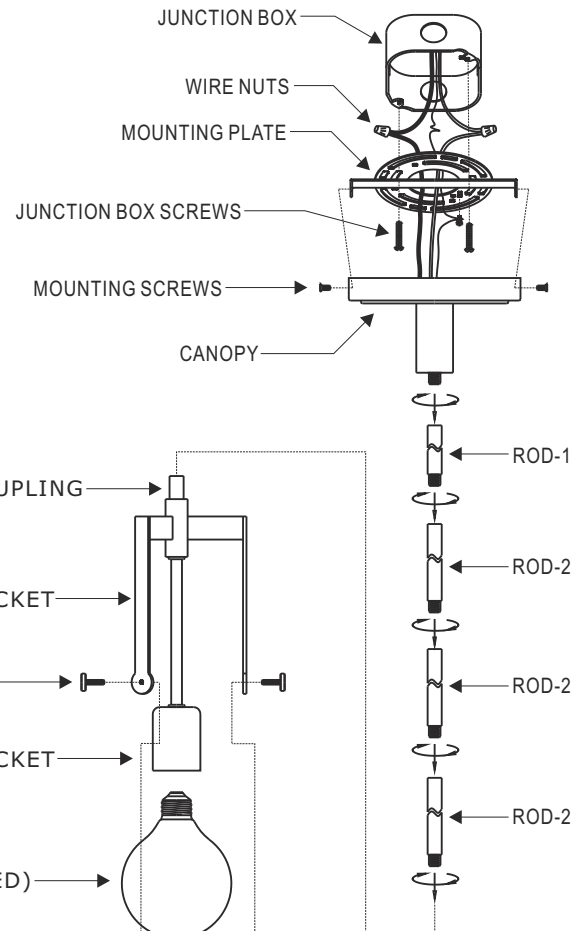

- Be sure to read and understand all instruction sheets completely before beginning assembly or installation.
- Be sure the power is turned off by removing the fuse or closing the circuit breaker.
- All assembly and installation work must be in accordance with National, State and Local electrical codes. We strongly advise using a licensed electrician.
- Be aware that the weight of some fixtures may exceed the strength rating of the 4" electrical junction box or other such hardware at your site. In all cases, it is the responsibility of the contractor to properly secure the fixture to the structure, and to provide adequate support for the fixture.
- Due to constant production improvements, details of the design, material or finish may change in any way that will not significantly alter installed appearance or reduce function or performance.