

WARNING: DISCONNECT POWER AT THE MAIN FUSE BOX BEFORE INSTALLATION.

WARNING:

This fixture is intended for installation in accordance with the National Electrical Code (NEC) and all local code specifications. If you are not familiar with code requirements, installation by a certified electrician is recommended.

Before assembly, remove all parts and part packages from box. If anything is missing, please contact the retailer from which the product was purchased.

elk HOME

ANY QUESTIONS CALL: 800-613-3261
M-F 8:00AM-6:00PM ET

ITEM#: 66595/3

1. Carefully pull house wires out of junction box so they are easily accessible during installation.
2. Position mounting bracket (A) so threaded ends of attached fixture mounting screws (E) are facing down towards floor.
3. Carefully pull house wires through center hole in mounting bracket (A).
4. Align holes in mounting bracket (A) with holes in junction box.
5. Thread each junction box screw (B) into holes in mounting bracket (A) and into holes in junction box. Tighten junction box screws (B) to secure mounting bracket (A) to junction box.

CAUTION: Make sure house wires are pulled completely through hole in mounting bracket. **DO NOT** pinch wires between mounting bracket and ceiling.

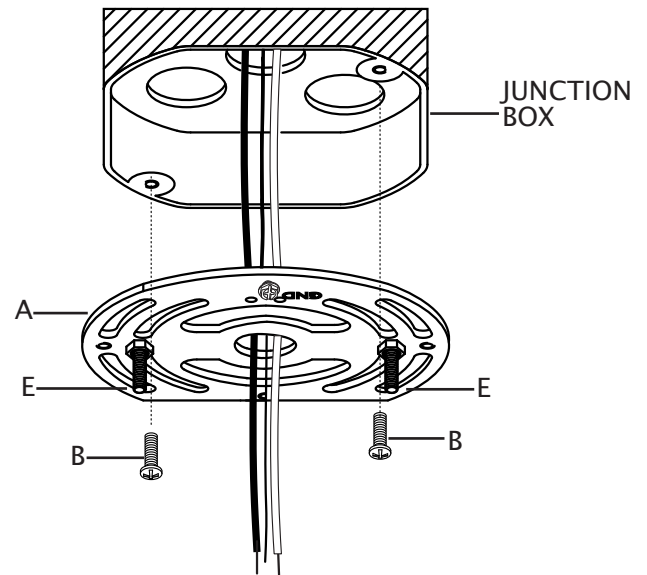

6. Carefully push fixture wires up through bottom of 6 inch stem (N). Pull fixture wires out of top of 6 inch stem (N). Screw bottom of 6 inch stem (N) onto top of fixture body (O).
7. Pass fixture wires through remaining stems (M). Attach remaining stems (M) to top of 6 inch stem (N).
8. Pass fixture wires up through swivel on canopy (D). Pull wires up through canopy (D). Thread last stem (M) onto swivel on canopy (D).

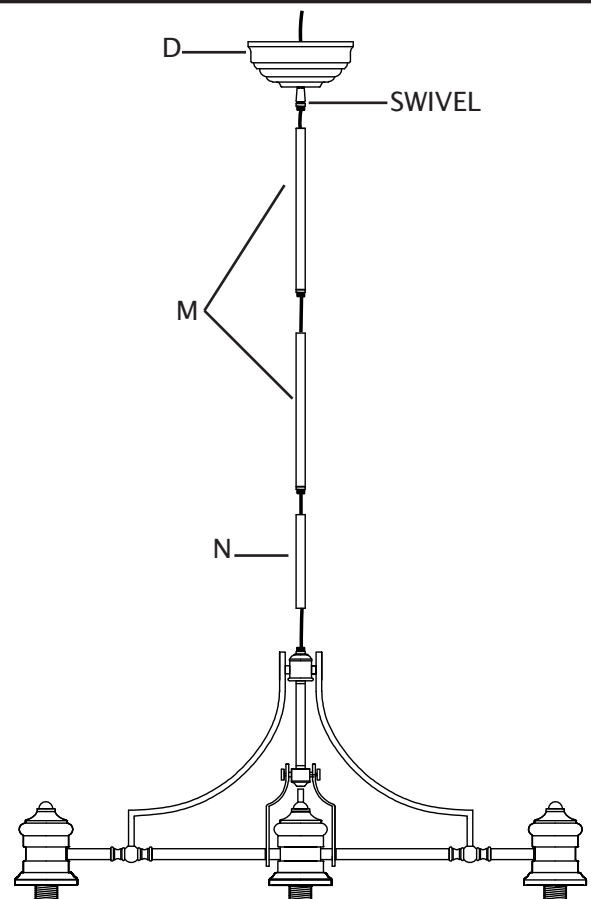

9. Strip 3/4" of insulation from ends of fixture wires.
10. Slightly loosen ground screw on mounting bracket (A). Do not completely remove ground screw. Wrap house ground wire (copper) around ground screw, leaving enough ground wire to attach to fixture ground wire. Twist end of fixture ground wire and end of house ground wire (copper) together. Twist wire connector (C) onto ends of wires. Completely tighten wire connector (C). Reference chart below for correct wire connections.

Connect Supply (House) Ground Copper Wire to:
Bare Copper Wire or,
Bare Silver Wire or,
Green Insulated Wire.

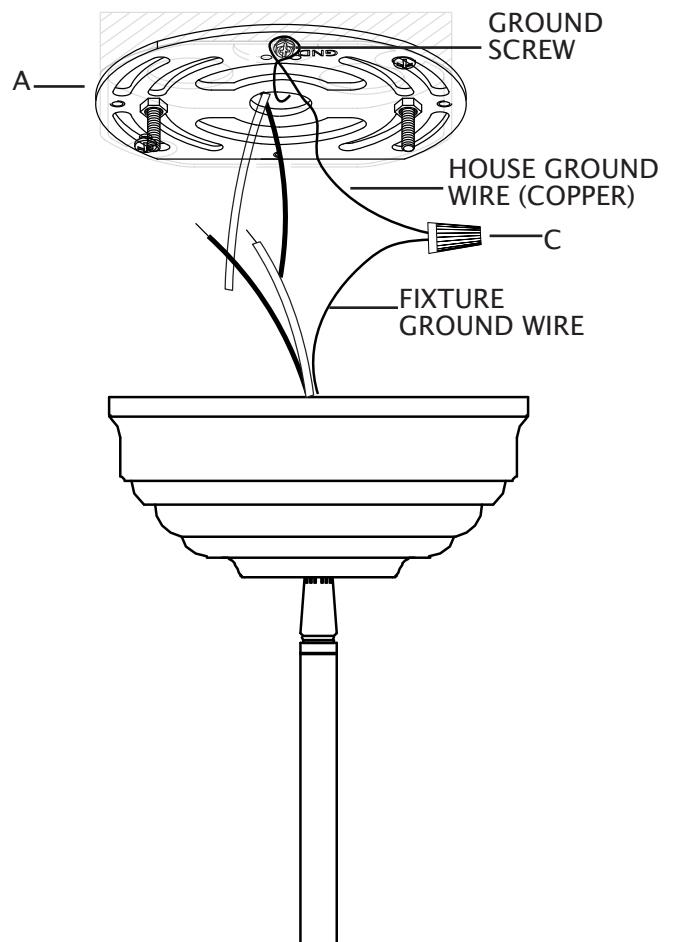

11. Twist end of house lead wire (black) and end of fixture lead wire together. Twist wire connector (C) onto ends of wires. Completely tighten wire connector (C). Twist end of house neutral wire (white) and end of fixture neutral wire together. Twist wire connector (C) onto ends of wires. Completely tighten wire connector (C). Reference chart to the right for correct wire connections.
12. Wrap electrical tape (not included) around wire connectors (C) and wires. Ensure wires are securely fastened into wire connectors.
13. Carefully push all wires and wire connectors into junction box.

Connect Black Lead Supply (House) Wire to:	Connect White Neutral Supply (House) Wire to:
Black Wire or,	White Wire or,
*Parallel Cord (Round and Smooth) or,	*Parallel Cord (Square and Ridged) or,
No printed words on wire insulation or,	Printed words on wire insulation or,
Insulated Wire (other than green) with Copper Conductor.	Insulated Wire (other than green) with Silver Conductor.

*When parallel wire (SPT 1 & SPT 2) is used:
The lead wire is round in shape or smooth.
The neutral wire is square in shape or ridged.

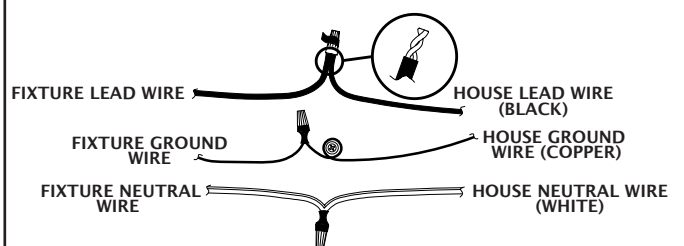

14. Carefully raise fixture up to ceiling. Place canopy (D) over mounting bracket (A). Pass holes in canopy (D) over ends of fixture mounting screws (E).
15. Screw one threaded cap (F) onto end of each fixture mounting screw (E). Tighten threaded caps (F) to secure fixture to ceiling. DO NOT over tighten.
16. Raise shade (K) up to fixture. Pass hole in top of shade (K) over socket. Thread socket ring (L) onto socket. Tighten socket ring (L) to secure shade (K) in place. DO NOT over tighten.
17. Screw recommended bulbs (E26 Edison bulb type, not included) into sockets. Verify correct bulb wattage marked on socket of fixture.
WARNING: DO NOT exceed maximum bulb wattage.
18. Place glass lens (P) onto bottom of shade (K). Fit glass lens (P) over bottom edge of shade (K).
19. Thread one thumbscrew (R) into each hole along glass lens (P). DO NOT completely tighten thumbscrews (R) until all thumbscrews have been installed. After all thumbscrews (R) have been installed completely tighten thumbscrews (R) to secure glass lens (P) to shade (K).

