

**WARNING:** DISCONNECT POWER AT THE MAIN FUSE BOX BEFORE INSTALLATION.

**WARNING:**

This fixture is intended for installation in accordance with the National Electrical Code (NEC) and all local code specifications. If you are not familiar with code requirements, installation by a certified electrician is recommended.

Before assembly, remove all parts and part packages from box. If anything is missing, please contact the retailer from which the product was purchased.



ANY QUESTIONS CALL: 800-613-3261  
M-F 8:00AM-6:00PM ET

ITEM#: 7003FM/60

1. Carefully pull house wires out of junction box so they are easily accessible during installation.
2. Position the mounting bracket (B) so the raised center portion is pointing upwards. Thread each fixture mounting screw (E) into holes in mounting bracket (A) closest to raised center of mounting bracket (A) approx. 3/4 of the way into the mounting bracket (A).
3. Hold mounting bracket (A) so raised center of mounting bracket (A) is protruding into junction box. Align each hole at ends of mounting bracket (A) with holes in junction box. Thread one junction box screw (B) into each hole in mounting bracket (A) and into holes in junction box. Tighten junction box screws (B) to secure mounting bracket (A) to junction box.

**CAUTION:** Make sure house wires are pulled completely through hole in mounting bracket. **DO NOT** pinch wires between mounting bracket and ceiling.

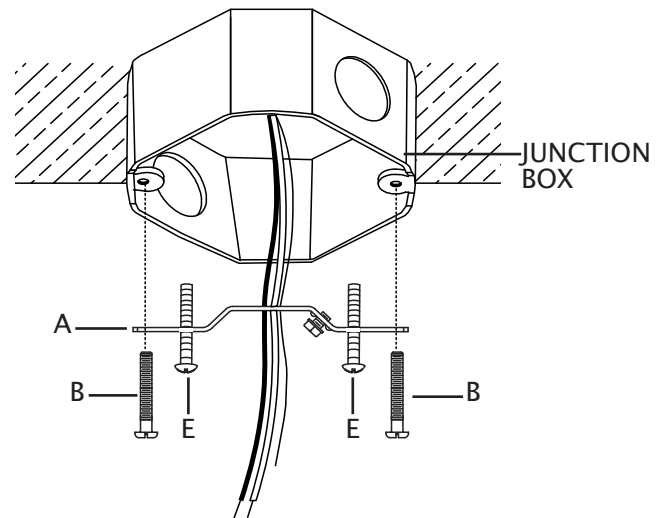

4. Strip 3/4" of insulation from ends of fixture wires.
5. Slightly loosen ground screw on mounting bracket (A). Do not completely remove ground screw. Wrap house ground wire (copper) around ground screw, leaving enough ground wire to attach to fixture ground wire. Twist end of fixture ground wire and end of house ground wire together. Twist wire nut (C) onto ends of wires. Completely tighten wire nut (C). Reference chart below for correct wire connections.

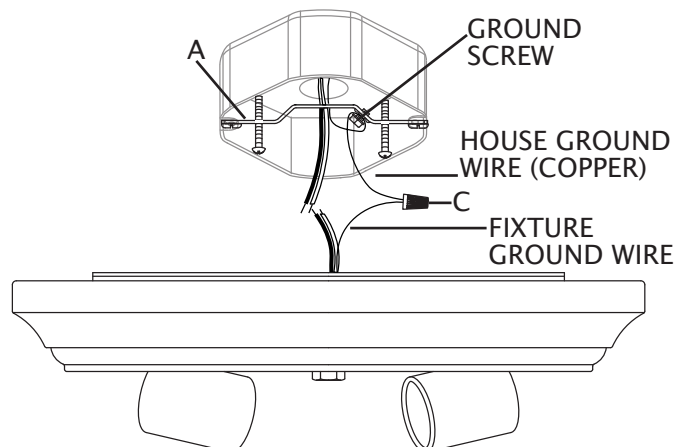

Connect Supply (House) Ground Copper Wire to:
Bare Copper Wire or,
Bare Silver Wire or,
Green Insulated Wire.

6. Twist end of house lead wire (black) and end of fixture lead wire together. Twist wire nut (C) onto ends of wires. Completely tighten wire nut (C). Twist end of house neutral wire (white) and end of fixture neutral wire together. Twist wire nut (C) onto ends of wires. Completely tighten wire nut (C). Reference chart to the right for correct wire connections.
7. Wrap electrical tape (not included) around wire nuts (C) and wires. Ensure wires are securely fastened into wire nuts.
8. Carefully push all wires and wire nuts into junction box.

Connect Black Lead Supply (House) Wire to:	Connect White Neutral Supply (House) Wire to:
Black Wire or,	White Wire or,
*Parallel Cord (Round and Smooth) or,	*Parallel Cord (Square and Ridged) or,
No printed words on wire insulation or,	Printed words on wire insulation or,
Insulated Wire (other than green) with Copper Conductor.	Insulated Wire (other than green) with Silver Conductor.

\*When parallel wire (SPT 1 & SPT 2) is used:  
The lead wire is round in shape or smooth.  
The neutral wire is square in shape or ridged.

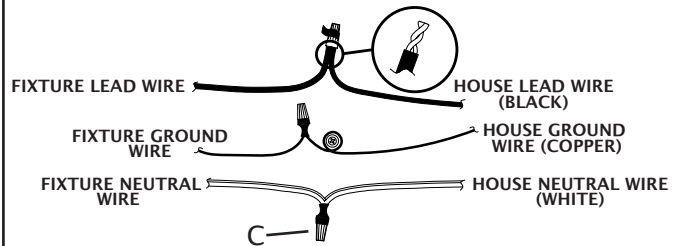

9. Carefully raise fixture up to ceiling. Align heads of each fixture mounting screw (E) on mounting bracket (A) with the larger hole in each keyhole slot in backpan (D). Pass larger holes in each keyhole slot over head of fixture mounting screws (E). Rotate backpan (D) so fixture mounting screws (E) fit into narrow hole in keyhole slots. Tighten fixture mounting screws (E) to secure backpan (D) to ceiling.

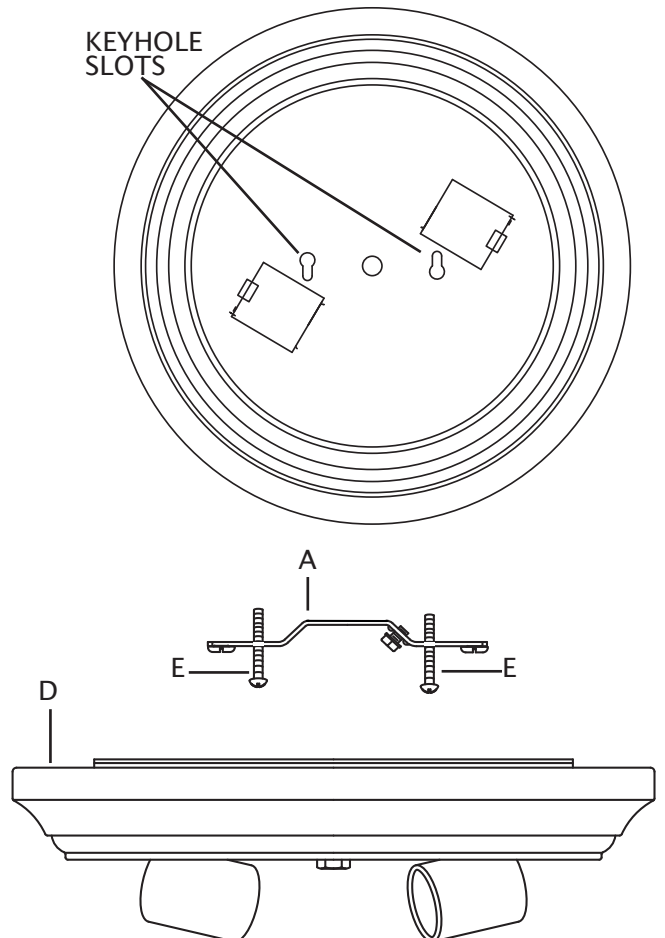

10. Screw recommended bulbs (E26 Edison bulb type, not included) into sockets. Verify correct bulb wattage marked on socket of fixture.  
**WARNING: DO NOT** exceed maximum bulb wattage.
11. Hold center pipe (F) so the end of center pipe (F) with the bead is at the top. Thread end of center pipe (F) with bead into coupling in center of backpan (D).
12. Carefully raise shade (K) up to fixture. Pass hole in center of shade (K) over end of center pipe (F).
13. Slip rubber washer (G) over end of center pipe (F) protruding from bottom of shade (K).
14. Slip flat washer (H) over end of center pipe (F) protruding from bottom of shade (K).
15. Thread hexnut (L) onto end of center pipe. Tighten hexnut (L) to secure shade (K) in place. **DO NOT** over tighten.
16. Slip hole in bottom trim (M) over end of center pipe (F) protruding from bottom of shade (K).
17. Thread finial (N) on to end of center pipe (F). Tighten finial (N) to secure bottom trim (M) in place. **DO NOT** over tighten.

