

- Be sure to read and understand all instruction sheets completely before beginning assembly or installation.
- All assembly and installation work must be performed by qualified personnel, in accordance with all applicable national and local building and electrical codes.
- Be aware that the weight of some fixtures may exceed the strength rating of the 4" electrical junction box or other such hardware at your site. In all cases, it is the responsibility of the contractor to properly secure the fixture to the structure, and to provide adequate support for the fixture.
- Due to constant production improvements, details of the design, material or finish may change in any way that will not significantly alter installed appearance or reduce function or performance.

© East Taunton, MA 02718 (508) 977-9991

INSTALLATION OF FIXTURE

- 1) PULL ELECTRICAL FEED WIRES FROM J-BOX THRU THE CENTER HOLE OF THE CROSSBAR.
- 2) ATTACH CROSSBAR TO J-BOX WITH 2 SCREWS PROVIDED.
- 3) CONNECT THE ELECTRICAL WIRES FROM YOUR J-BOX TO THE WIRES FROM THE FIXTURE BODY USING WIRE NUTS. (BLACK TO BLACK, WHITE TO WHITE, GREEN TO GROUND)
- 4) ATTACH THE FIXTURE BODY TO THE CROSSBAR WITH THE 2 MOUNTING SCREWS.
- 5) SCREW LAMP INTO SOCKET. (LAMP BY OTHER)
- 6) SCREW GLASS DIFFUSER ONTO THE FIXTURE BODY.

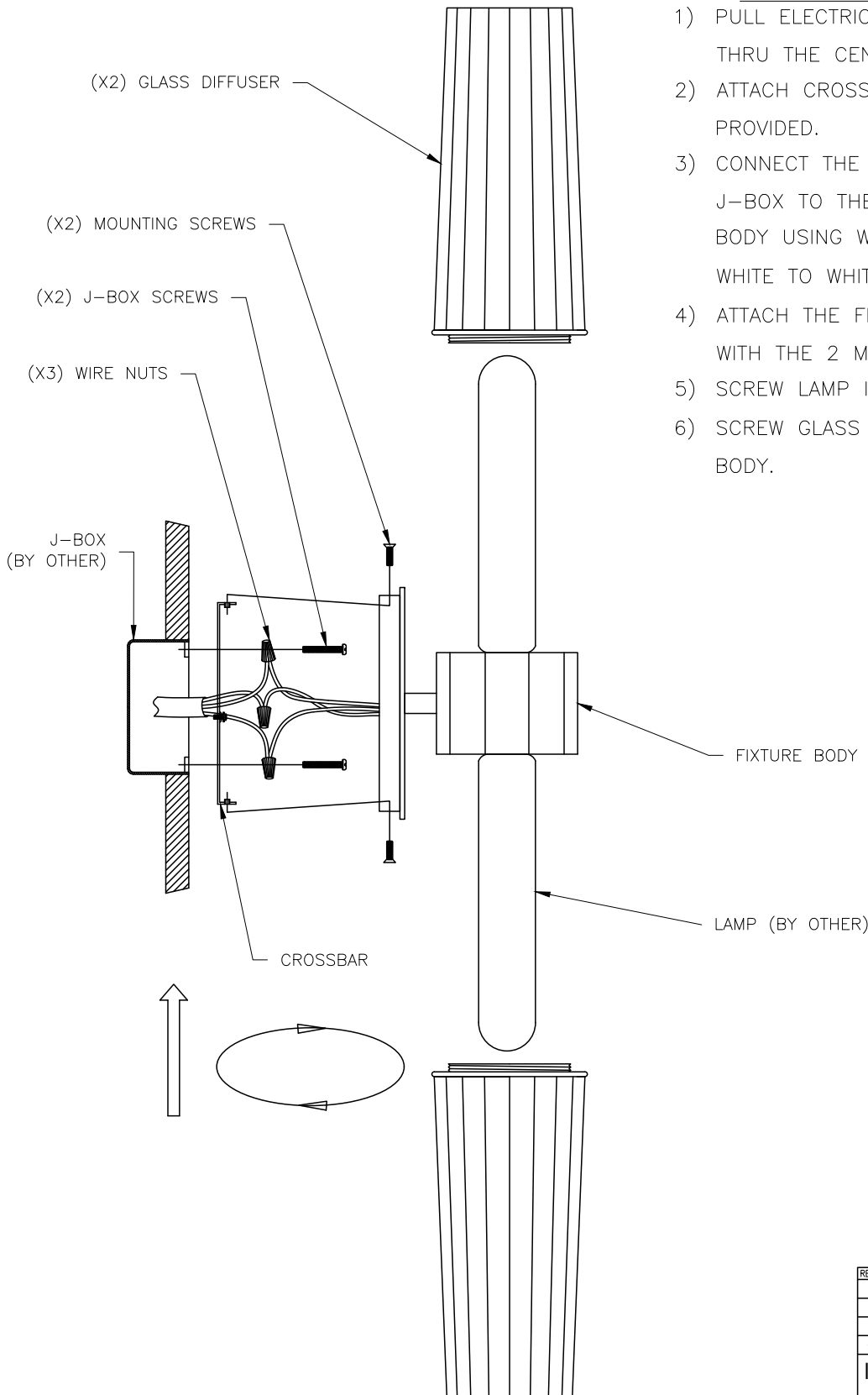

Norwell Lighting

REV.	BY	DATE	DESCRIPTION
INSTRUCTIONS			DRAWN BY: CAC
9759 - ICYCLE			SHEET #: SHEET 1 OF 1
DATE:	Dec 30, 2020		DWG: 9759-INST

FILENAME:
9759 INSTALL