

WARNING: DISCONNECT POWER AT THE MAIN FUSE BOX BEFORE INSTALLATION.

WARNING:

This fixture is intended for installation in accordance with the National Electrical Code (NEC) and all local code specifications. If you are not familiar with code requirements, installation by a certified electrician is recommended.

Before assembly, remove all parts and part packages from box. If anything is missing, please contact the retailer from which the product was purchased.

elk HOME

ANY QUESTIONS CALL: 800-613-3261
M-F 8:00AM-6:00PM ET

ITEM#: SL710441

1. Position mounting bracket (A) so head of ground screw is on outside of mounting bracket (A).
2. Align holes in mounting bracket with holes in junction box. While holding mounting bracket in correct position, mark with a pencil on wall the location of two (2) outer holes in mounting bracket. Set bracket aside while installing anchors.
3. Using a drill bit the appropriate size for the wall anchor (W), drill a hole at each marked location on wall.
4. Using hammer, carefully tap one anchor (W) into each hole. Lip of anchor (W) should be flush with wall.
5. Carefully pull house wires out of junction box and pass house wires through large center hole in mounting bracket (A).
6. Align holes in the mounting bracket (A) with holes in junction box. Align holes in ends of mounting bracket with anchors (W) in wall.
7. Thread each junction box screw (B) into appropriate hole in mounting bracket (A) and into hole in junction box.
8. Thread each anchor screw (V) into each hole in mounting bracket (A) and into wall anchors (W).
9. Tighten junction box screws (B) and anchor screws (V) to attach mounting bracket (A) to junction box.
CAUTION: Make sure house wires are still easily accessible. DO NOT pinch wires between mounting bracket and wall.

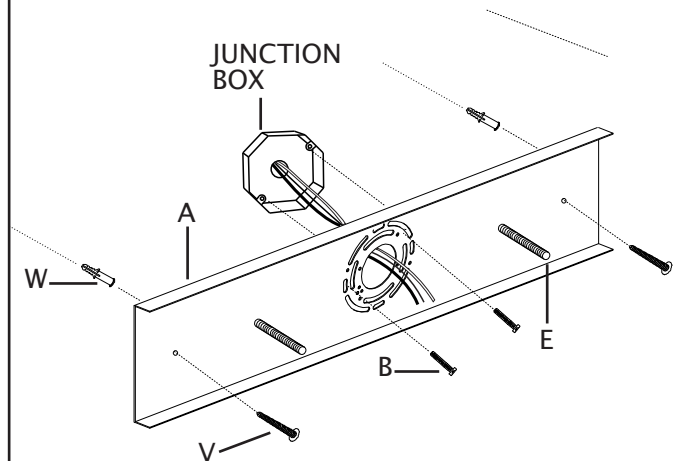

10. Strip 3/4" of insulation from ends of fixture wires.
11. Slightly loosen ground screw on mounting bracket (A). Do not completely remove ground screw. Wrap ground wire from junction box around ground screw, leaving enough ground wire to attach to fixture ground wire. Twist end of fixture ground wire and end of house ground wire together. Twist wire nut (C) onto ends of wires. Completely tighten wire nut (C). Reference chart below for correct wire connections.

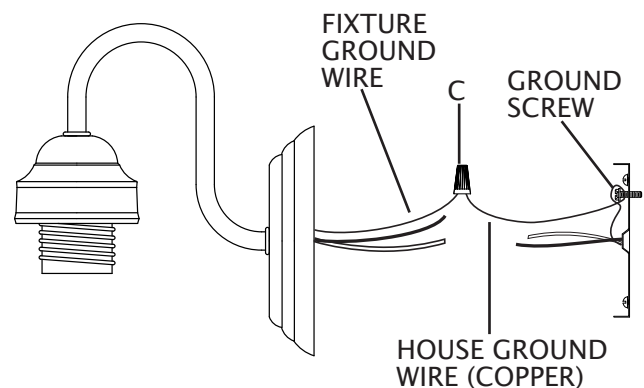

Connect Supply (House) Ground Copper Wire to:

Bare Copper Wire or,

Bare Silver Wire or,

Green Insulated Wire.

12. Twist end of house lead wire (black) and end of fixture lead wire together. Twist wire nut (C) onto ends of wires. Completely tighten wire nut (C). Twist end of house neutral wire (white) and end of fixture neutral wire together. Twist wire nut (C) onto ends of wires. Completely tighten wire nut (C). Reference chart to the right for correct wire connections.
13. Wrap electrical tape (not included) around wire nuts (C) and wires. Ensure wires are securely fastened into wire nuts.
14. Carefully push all wires and wire nuts into junction box.

Connect Black Lead Supply (House) Wire to:	Connect White Neutral Supply (House) Wire to:
Black Wire or,	White Wire or,
*Parallel Cord (Round and Smooth) or,	*Parallel Cord (Square and Ridged) or,
No printed words on wire insulation or,	Printed words on wire insulation or,
Insulated Wire (other than green) with Copper Conductor.	Insulated Wire (other than green) with Silver Conductor.

*When parallel wire (SPT 1 & SPT 2) is used:
The lead wire is round in shape or smooth.
The neutral wire is square in shape or ridged.

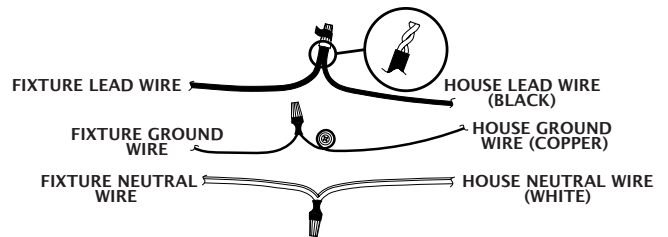

15. Place backplate (D) over mounting bracket (A). Pass holes in backplate (D) over ends of fixture mounting screws (E).
16. Screw one threaded cap (F) onto ends of fixture mounting screws (E). Tighten threaded caps (F) to secure fixture in place. DO NOT over tighten.
17. Pass hole in top of shade (K) over socket. Thread socket ring (L) onto socket. Tighten socket ring (L) to secure shade (K) in place. DO NOT over tighten.
18. Screw recommended bulbs (E26 Edison bulb type, not included) into sockets. Verify correct bulb wattage marked on socket of fixture. **WARNING:** DO NOT exceed maximum bulb wattage.

