	ITEM #:	14585/1
	UPC	748119139746
	Description	Carbondale 1-Light Pendant in Slate Mist and Satin Nickel with Slate Mist Metal Shade
	Finish	Slate Mist, Satin Nickel
	Materials	Steel
	Brand	ELK Lighting
	Collection	Carbondale
	Category	Indoor Lighting
	Type	Pendant

ITEM DIMENSIONS				RATINGS & SPECIFICATIONS				
Width	14 inches			Safety Rating	ETL		Certification	Dry locations
Depth	14 inches			ADA Compliant	N/A		Voltage	120 volts
Height	9 inches			BULBS / SOCKETS				
Weight	4 pounds			Quantity	1	Wattage	100 watts	
ADDITIONAL DIMENSIONS				Included	No		Type	A19 (E26 Medium Base)
Backplate / Canopy	4.75 diameter			Other	N/A			
HCWO	N/A			CHAIN / CORD INFORMATION				
Min. Extension	N/A			Chain	N/A		Cord	72 inches
Max. Extension	N/A			SHADE / GLASS DETAILS				
OVERALL HEIGHT				Shade/Glass Description	Slate Mist Metal Shade			
Min.	17 inches		Max.	53 inches				
EXTENSION ROD(S)				Width	14 inches		Height	8 inches
Rods: 1-6, 3-12				Width at Top	N/A		Width at Bottom	N/A

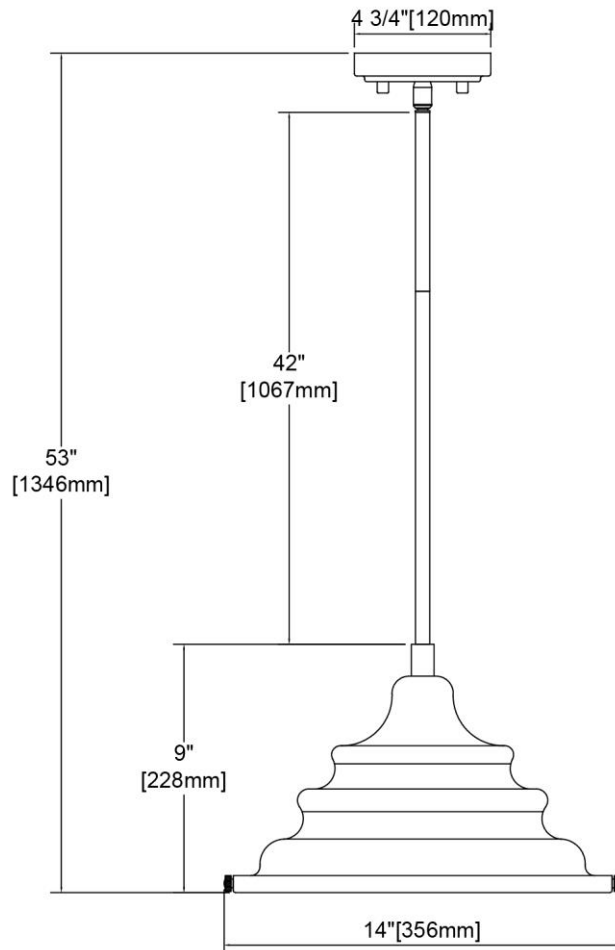

Rev. 12/12/2019